

# Table of Contents

<b>INTRODUCTION</b> .....	<b>2</b>
Parts Check List .....	3
<b>IMPORTANT SAFETY INSTRUCTIONS</b> .....	<b>4</b>
<b>REPLACING THE HANDSET BATTERIES</b> .....	<b>6</b>
<b>GETTING STARTED</b> .....	<b>8</b>
Setting Up Your <i>VTech 912 ADLc</i> .....	8
<b>WALL MOUNTING</b> .....	<b>10</b>
<b>HANDSET FEATURES</b> .....	<b>12</b>
IN USE LED .....	12
LOW BATTERY LED .....	12
PHONE KEY / FLASH FUNCTION .....	12
CHANNEL KEY .....	12
OFF KEY .....	12
MEM KEY .....	12
PROG KEY .....	12
REDIAL KEY .....	12
TONE / * KEY .....	12
VOLUME CONTROL SWITCH .....	12
<b>BASE UNIT FEATURES</b> .....	<b>13</b>
POWER LED .....	13
CHARGE LED .....	13
IN USE LED .....	13
SPARE BATTERY LED .....	13
PAGE KEY .....	13
TONE/PULSE SWITCH .....	13
<b>OPERATING INSTRUCTIONS</b> .....	<b>14</b>
Making Calls .....	14
Answering Calls .....	14
Disconnecting .....	14
Changing Channels .....	14
Temporary Tone .....	15
Programming The Ringer Type .....	15
Turning Off The Ringer .....	15
Checking The Ringer .....	16
Memory Dialing .....	16
Programming Speed Dial Numbers .....	16
Speed Number Dialing .....	16
To Change or Replace a Speed Dial Number .....	16
Storing Special Codes .....	17
Using Redial .....	17
Storing a Redial Number into Speed Dial .....	17
The Page Feature .....	18
<b>CALLER ID</b> .....	<b>19</b>
Caller ID LCD and Icons .....	19
Caller ID Operating Key Descriptions .....	21
Caller ID Setup .....	21
Reviewing Caller ID Information .....	23
Repeat Counter .....	23
Deleting Caller ID Memory .....	24
Manual Reset .....	24
<b>MAINTENANCE</b> .....	<b>25</b>
<b>IN CASE OF DIFFICULTY</b> .....	<b>26</b>
<b>WARRANTY STATEMENT</b> .....	<b>28</b>
<b>FCC REGULATIONS</b> .....	<b>29</b>
<b>TECHNICAL SPECIFICATIONS</b> .....	<b>31</b>

# INTRODUCTION

Congratulations! You have purchased one of the best performing cordless telephones on the market! The **VTech 912 ADLc** is a single line 900 MHz cordless phone with Alpha Numeric Caller ID module in Base Unit.

The **VTech 912 ADLc** has automatic security code reset. This means that one of more than 65 thousand possible digital security codes is randomly selected every time the handset is placed in the base unit. The handset and base unit will recognize each other based on this security code which minimizes the chances of another cordless phone using your telephone line. The base unit stores the current security code and channel in memory even if the unit is unplugged.

#### **Caller ID features:**

- Displays Name, Number, Time & Date of call simultaneously
- Call memory can at least keep the latest 75 calls up to a maximum of 99 Calls
- Ability of setting current date and time
- Forward / Backward Reviewing capability
- Delete single/all message(s)
- "Message wait" icon indicator
- Display Time / Date & total calls in clock mode (Standby mode)
- "REPEAT#" icon & "NEW CALL" icon
- Compatible with Single / Multiple Message format
- 3 keys simple operation
- "New call" LED indicator
- Manual reset available
- Support 3 major languages: English, Spanish & French

#### **Other special features are:**

- 10 Number Speed Dial Memory
- 10 Channels of operation
- Automatic Search for Available Channel
- Manual Channel Change on Handset
- PAGE from Base to Handset
- REDIAL feature
- Programmable Ringer Types
- Low Battery Detect and Warning indicator
- Hearing-Aid Compatible Receiver
- Easy answer - when the phone rings simply press any key on the handset to answer (EXCEPT OFF).
- Removable battery pack
- Extra Battery Charger in the base unit
- Touch Tone and Pulse Dialing
- Temporary Tone Mode

This manual is designed to familiarize you with the **VTech 912 ADLc**. To get the most use out of your **VTech 912 ADLc**, we strongly recommend you read the manual before using your phone.

# INTRODUCTION

## Parts Check List:

1. Handset
2. Base unit
3. AC adapter
4. Telephone line cord
5. Battery pack
6. Wall mounting bracket

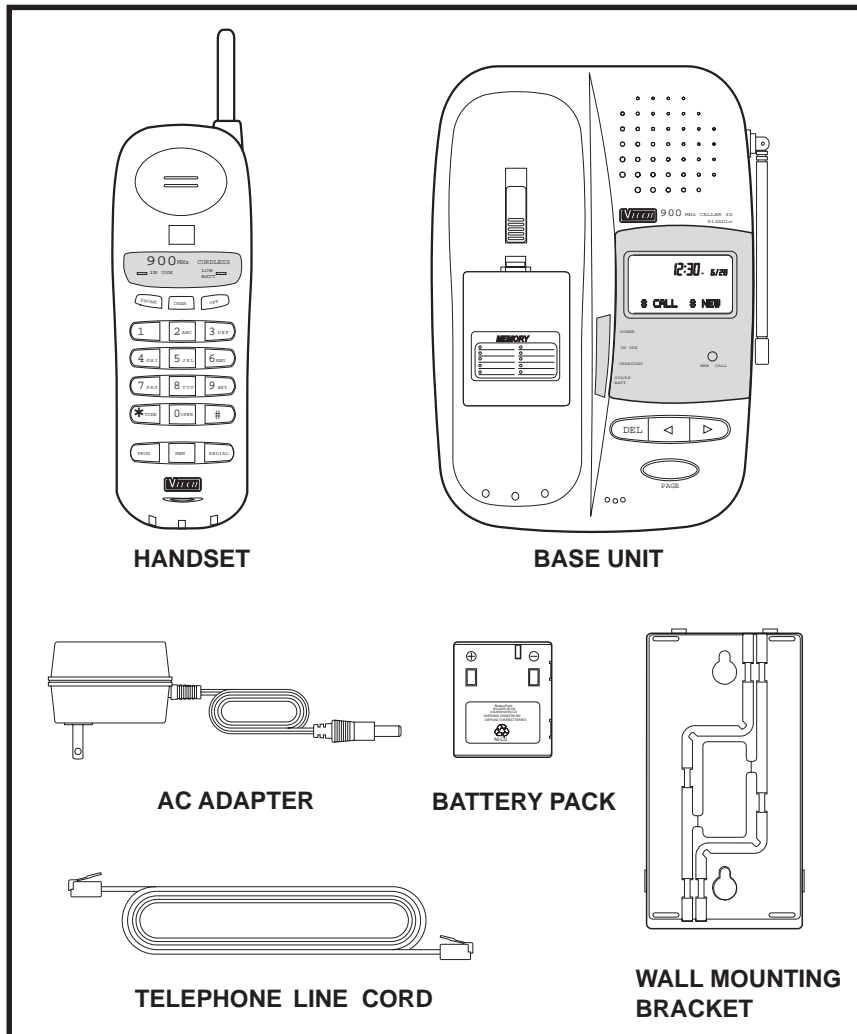

# **IMPORTANT SAFETY INSTRUCTIONS**

When using your telephone equipment, basic safety precautions should always be followed to reduce the risk of fire, electric shock and injury to persons, including the following:

1. Read and understand all instructions.
2. Follow all warning and instructions marked on the product.
3. Unplug this product from the wall outlet before cleaning. Do not use liquid cleaners or aerosol cleaners. Use a damp cloth for cleaning.
4. Do not use this product near water (for example, near a bath tub, kitchen sink, or swimming pool).
5. Do not place this product on an unstable cart, stand, or table. The product may fall, causing serious damage to the product.
6. Slots and openings in the cabinet and the back or bottom are provided for ventilation. To protect it from overheating, these openings must not be blocked by placing the product on the bed, sofa, rug, or other similar surface. This product should never be placed near or over a radiator or heat register. This product should not be placed in a built-in installation where proper ventilation is not provided.
7. This product should be operated only from the type of power source indicated on the marking label. If you are not sure of the type of power supply to your home, consult your dealer or local power company.
8. Do not allow anything to rest on the power cord. Do not locate this product where the cord will be abused by persons walking on it.
9. Never push objects of any kind into this product through cabinet slots as they may touch dangerous voltage points or short out parts that could result in a risk of fire or electric shock. Never spill liquid of any kind on the product.
10. To reduce the risk of electric shock, do not disassemble this product. If service or repair work is required, contact VTech Customer Service at 1-800-624-5688. Opening or removing cabinet parts other than specified access doors may expose you to dangerous voltages or other risks. Incorrect reassembling can cause electric shock when the appliance is subsequently used.
11. Do not overload wall outlets and extension cords as this can result in the risk of fire or electric shock.

## **IMPORTANT SAFETY INSTRUCTIONS**

12. Unplug this product from the wall outlet :
  - A. When the power supply cord or plug is damaged or frayed.
  - B. If liquid has been spilled into the product.
  - C. If the product has been exposed to rain or water.
  - D. If the product does not operate normally by following the operating instructions. Adjust only those controls that are covered by the operating instructions because improper adjustment of other controls may result in damage and will often require extensive work to restore the product to normal operation.
  - E. If the product has been dropped and the cabinet has been damaged.
  - F. If the product exhibits a distinct change in performance.
13. Avoid using a telephone (other than a cordless type) during an electrical storm. There may be a remote risk of electric shock from lightning.
14. Do not use the telephone to report a gas leak in the vicinity of the leak.

## **SAVE THESE INSTRUCTIONS**

# REPLACING THE HANDSET BATTERIES

1. Remove the battery case by pressing on the ridged lines and sliding downward.



2. Discard the old battery pack. Don't put the old battery pack in a trash compactor or a fire - it could burst.

**IMPORTANT:** Do not dispose of this battery in household garbage. For information on recycling or proper disposal, consult your local solid waste collection or disposal organization.

3. Place the new battery pack in the battery compartment. Make sure the metal contacts on the underside of the battery are aligned with charging contacts in battery compartment. Replace the battery case cover.



4. The new battery pack must be charged before using your telephone. Place the handset in the cradle of the base unit to allow it to charge for 24 hours. Maximum battery life between charges is 7 hours of continuous talk time or 6 days of standby.

**CAUTION:** To reduce the Risk of Fire or Injury to Persons, Read and Follow these Instructions:

1. Use only VTECH battery.
2. Do not open or mutilate the battery. Released electrolyte is corrosive and may cause damage to the eyes or skin. It may be toxic if swallowed.
3. Exercise care in handling batteries in order not to short the battery with conducting materials such as rings, bracelets, and keys. The battery or conductor may overheat and cause burns.
4. Do not dispose of the battery in a fire. The cell may explode.

## IF THE BATTERY PACK DOESN'T RECHARGE

The battery pack can be recharged many times; but if you get a low-battery signal, or the handset seems completely dead, even after 24 hours of charging, the battery pack should be replaced.

To purchase replacement battery packs, use the enclosed order form, or call Vtech Communications at 1-800-624-5688.

# REPLACING THE HANDSET BATTERIES

## **SPARE BATTERY CHARGER**

Your **VTech 912 ADLc** is equipped with a spare battery charger built-in to the base unit. The spare battery charger allows you to always have a charged battery available, should your handset battery discharge during normal use.

Contact your local VTech dealer, or call VTech Customer Service to purchase a spare battery pack.

### **To install the Spare Battery Pack:**

1. Open the base unit battery compartment
2. Place the spare battery pack in the battery compartment. Make sure the metal contacts on the underside of the battery are aligned with charging contacts in battery compartment.
3. Replace the battery compartment cover.
4. When the battery is installed properly, the spare battery LED on the base unit will be illuminated.
5. The spare battery will be fully charged after 24 hrs. Please note that the spare battery LED will always be illuminated when a spare battery is installed.

# GETTING STARTED

## Setting Up Your VTech 912 ADLc

1. Choose an area near an electrical outlet and a telephone wall jack.

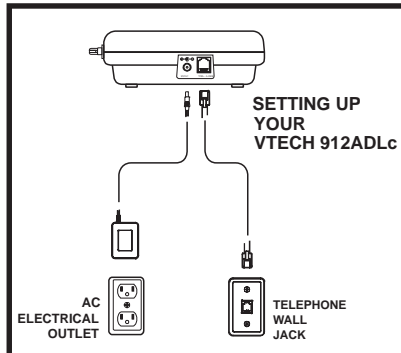

2. Connect the telephone line cord. Insert one end of the telephone line cord into the jack at the rear of the base unit. Plug the other end into a telephone wall jack. Make sure the plugs snap securely into place.
3. Plug the AC power adapter into an electrical outlet and the DC connector to the back of the base unit.

**CAUTION:** Use only the AC adapter shipped with your 912 ADLc. This is a Class 2 AC adapter, specifically designed for use with the 912 ADLc.

**NOTE:** Connect power to the base unit before placing the handset in the cradle.

4. Set the **TONE/PULSE** switch on the base unit. If you have touch tone service on your phone line, set the switch to **TONE**. If you have rotary service, set the switch to **PULSE**.

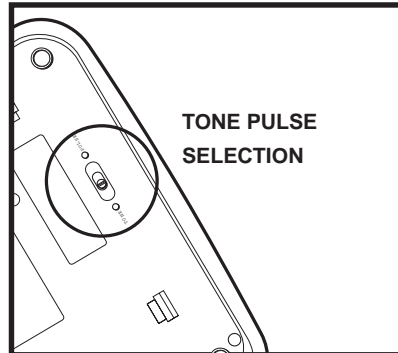

5. **CHARGE THE HANDSET BATTERIES BEFORE USE.** The batteries recharge automatically whenever the handset is in the base unit cradle. The batteries must be charged for 24 hours before using your phone for the first time. After the initial charge, a maintenance charge of 8 hours is sufficient to return a low battery to full condition.
6. **CHECK FOR A DIAL TONE.** After the batteries are charged, pick up the handset and press the **PHONE** key. The IN USE indicator should light up, and you should hear a dial tone. If not, see **IN CASE OF DIFFICULTY**.

# **GETTING STARTED**

**CAUTION:**

1. Never install telephone wiring during a lightning storm.
2. Never install telephone jacks in wet locations unless the jack is specifically designed for wet locations.
3. Never touch uninsulated telephone wires or terminals unless the telephone line has been disconnected at the network interface.
4. Use caution when installing or modifying telephone lines.

# WALL MOUNTING

1. **Choose a spot near an electrical outlet and a telephone jack.** Your phone requires a modular telephone jack and a standard electrical outlet (120v AC). The power cord is six feet long; make sure there is an electrical outlet within reach of the base. The outlet should not be controlled by a wall switch. If the switch is ever turned off, the phone will not operate.

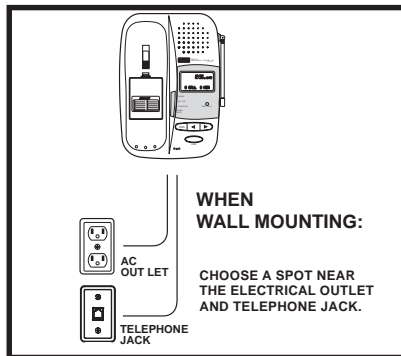

2. **Position the wall mount adapter on the base.** Line up the tabs on the wall mount adapter with the holes on the bottom of the base. Snap the wall mount adapter firmly in place.

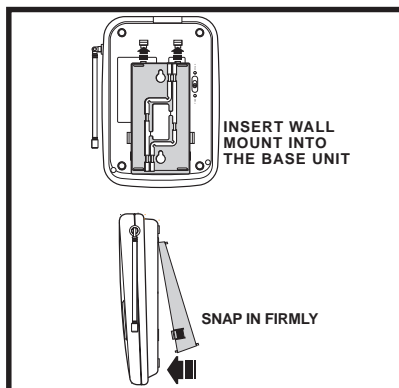

3. **Mount the base on the wall.** Position the base so the mounting studs will fit into the holes on the bottom of the base. Position the power cord to extend down the wall the phone is to be mounted on. Slide the base down on the mounting studs until it locks into place.

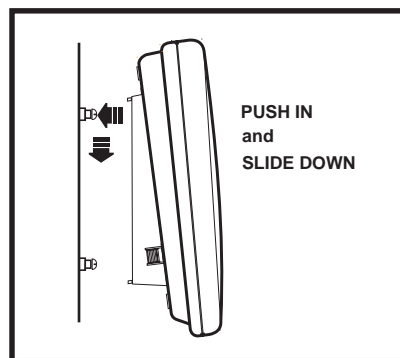

4. **Connect the telephone cord.** The telephone line cord has a snap-in plug at each end. Insert one of the plugs into the jack on the bottom of the base. Insert the other end of the plug into the wall jack.

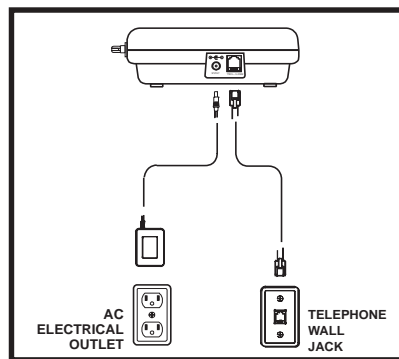

## WALL MOUNTING

5. Plug the AC adapter on the power cord into an electrical outlet.
6. **Set the dial mode switch on the base unit.** If you have touch tone service on your phone line, set the switch to TONE. If you have rotary service, set the switch to PULSE.

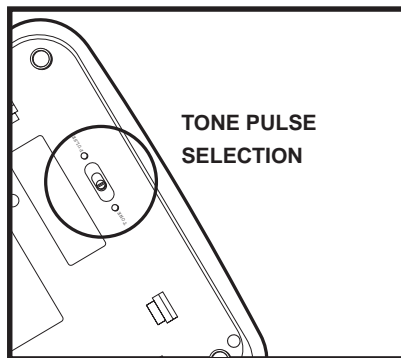

# HANDSET FEATURES



## IN USE LED

- The **IN USE** LED lights when the phone line is being used by the handset.
- It flashes in cadence with an incoming ring.
- It flashes quickly during **PROG** mode.

## LOW BATTERY LED

- The **Low Battery** LED will flash when the handset battery is getting low and needs to be recharged.

## PHONE KEY/FLASH FUNCTION

- Press the **PHONE** key to make a call.
- If you are currently on a call pressing **PHONE** flashes the line. This would be used with a feature like call waiting to answer your second call.

## CHANNEL KEY

- Pressing the **CHAN** key when the handset is in use will activate a channel change to the next free channel.
- This is used if you are experiencing noise or interference on the current channel.

## OFF KEY

- Press the **OFF** key to exit all modes of operation.

## MEM KEY

- Press the **MEM** key to enter MEMORY mode.
- The sequence for dialing out a speed dial number in memory is: **PHONE**, **MEM**, Number Button (**0-9**).

## PROG KEY

- Press **PROG** key to enter PROGRAM mode. See **Programming Speed Dial Numbers** for more details.

## REDIAL KEY

- When you hear the dial tone, pressing the REDIAL key will dial out the last number that was called on your phone.
- It can also be used to store the last number dialed into the speed dial memory. See **Storing a Redial Number into Speed Dial** for details.

## TONE/ KEY

- In **PU\*SE** dialing mode, this key is used to switch to Temporary TONE dialing mode.

## VOLUME CONTROL SWITCH

- There is a volume control switch on the side of the handset. Set the switch in either the high (H) or low (L) position, depending on your preference.

# **BASE UNIT FEATURES**

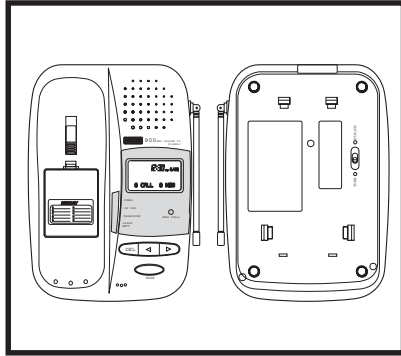

## **POWER LED**

- The **POWER LED** illuminates when the base power adapter is plugged in and power is applied to the base unit.

## **CHARGE LED**

- The **CHARGE LED** illuminates steadily when the handset is in the base cradle to indicate that the handset battery is being charged.

## **IN USE LED**

- Immediately after placing the handset in the base cradle, the **IN USE LED** begins to flash to indicate that initialization (assigning a new security code) is in progress.
- The **IN USE LED** will stop flashing and turn off when initialization is completed.
- The **IN USE LED** illuminates whenever the handset is being used.
- This LED also flashes with the cadence of the incoming ring.

## **SPARE BATTERY LED**

- The **SPARE BATTERY LED** illuminates steadily when a battery is placed in the base unit charge cradle.

## **PAGE KEY**

- Press the **PAGE** key to page the handset.
- Press it a second time to cancel a page.
- The base will ring the handset 4 times before ending the page automatically.
- The handset can also cancel the page by pressing the **OFF** key.

## **TONE/PULSE SWITCH**

- This switch will switch the phone between TONE dialling and PULSE dialling.

# OPERATING INSTRUCTIONS

**IMPORTANT:** Whenever the handset batteries are removed, the handset must be reinitialized on the base unit cradle after the batteries are replaced. The **In Use** LED on the base unit will flash during the initialization.

## Making Calls

Pick up the handset and press **PHONE**. When you hear a dial tone, dial the number. The indicator for **IN USE** (on the base unit) and **IN USE** (on the handset) will light.

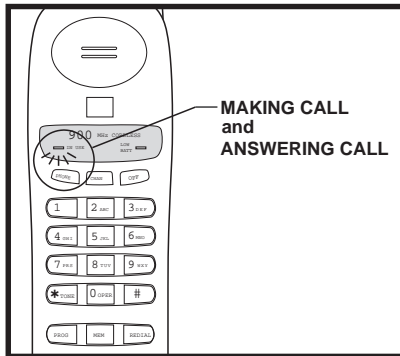

If you make a mistake when dialing, press **OFF** to hang up, then press **PHONE** to get the dial tone again.

You must always press **PHONE** before you can dial a call on the handset.

## Answering Calls

When an incoming call is ringing, the **IN USE** LED in the base and the **IN USE** LED in the handset will flash. To make sure your phone rings when the handset is away from the base, please keep the base antenna in the upright position.

To answer a call when the handset is in the base, just pick up the handset.

To answer a call when the handset is away from the base, just press any key on the handset (except **OFF**). This is very useful in a dark environment; you do not have to fumble around looking for the **PHONE** key to answer the call.

## Disconnecting

To end a call, either place the handset back in the base, or press **OFF** on the handset.

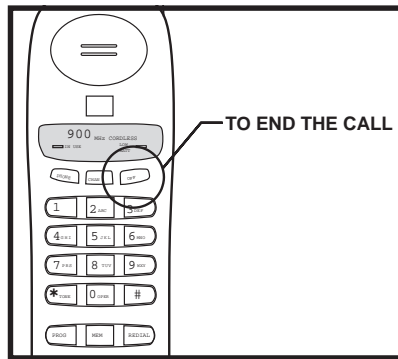

## Changing Channels

If you notice interference when using your handset, press **CHAN** to switch to a clear channel. This function is only available when you are on a call.

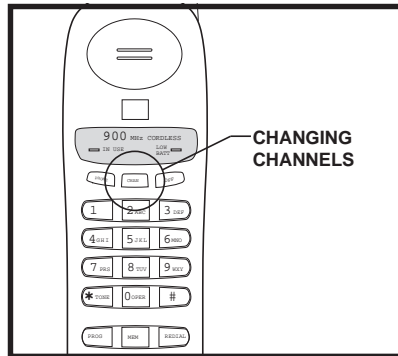

# OPERATING INSTRUCTIONS

## Temporary Tone

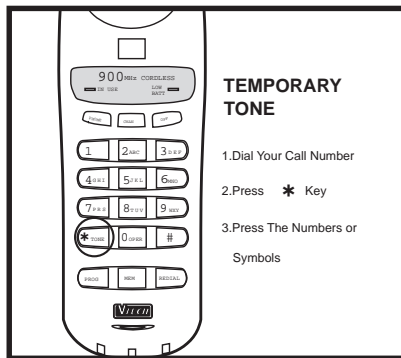

If you have a rotary (dial-pulse) telephone service, (**TONE/PULSE** switch is set to **PULSE**), this feature allows you to enter special codes and tones to operate answering machines, use electronic banking services, calling cards, or other special services.

First, dial the call normally. Then activate the Temporary Tone feature by pressing **TONE** (the \* key). You can then press the numbers or symbols you need, and your phone will send the proper signals.

To end the call, press **OFF** or place the handset back in the base. The phone will automatically go back to rotary (dial-pulse) service.

If you have touch-tone service, (**TONE/PULSE** switch set to **TONE**), just enter the codes normally. This feature is only for rotary service telephone lines.

## Programming The Ringer Type

The handset ringer is capable of four different types of ringing tones. The following sections detail how to change the different tones and to turn off a ringer on the handset.

To program, the handset must be **OFF**.

To select a different ringer type do the following:

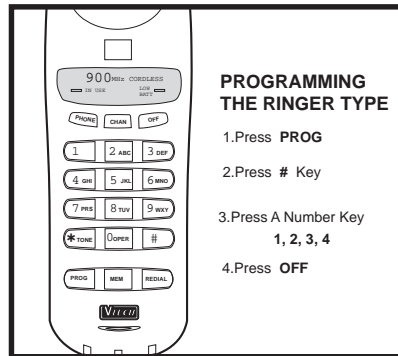

- Press **PROG**
- Press the # key.
- Press a key **1..4** to select a ringer type.
- Press the **OFF** key to exit.

## Turning Off The Ringer

To turn off the ringer on the handset, do the following:

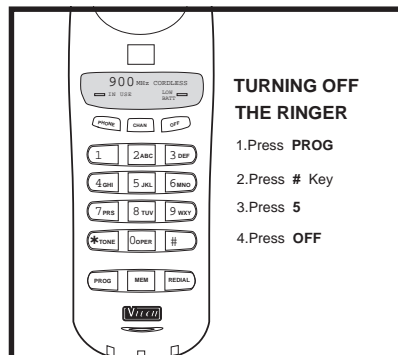

- Press **PROG**
- Press the # key
- Press the **5** to turn off the ringer
- Press the **OFF** key to exit
- To turn ringer on again, see **Programming the Ringer Type**.

# OPERATING INSTRUCTIONS

## Checking The Ringer

To check the ringer which is currently programmed, do the following:

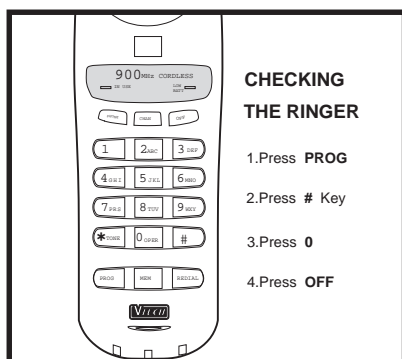

- Press **PROG**
- Press the **#** key
- Press **0**
- Press the **OFF** key to exit

## Memory Dialing

The **VTech 912 ADLc** can store up to 10 different phone numbers that you can dial just by pressing **MEM** and one of the number keys (**0-9**).

## Programming Speed Dial Numbers

The handset must be **OFF**.

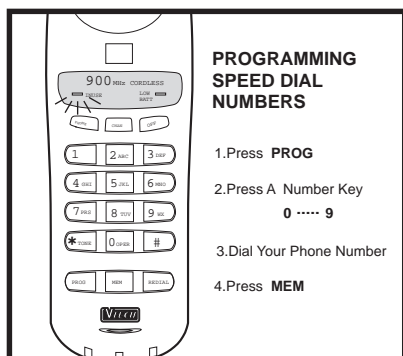

1. Press **PROG**. The **IN USE** LED will blink to indicate that you are in the programming mode.

2. Press the number of the memory location you wish to store the number in (**0-9**).

3. Using the dial pad, dial the number you want to store. The number can be up to 16 digits long. The number can be entered manually or by using **REDIAL**.

4. Press **MEM** to store the phone number to the key you selected.

The phone now exits **PROG** mode and emits a tone.

## Speed Number Dialing

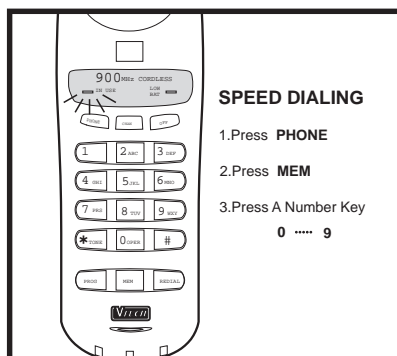

1. Press **PHONE** to get a dial tone.
2. Press **MEM** and the memory location number key (**0-9**).

For example, to dial the number you assigned to key '8', you would press **PHONE, MEM, 8**.

## To Change or Replace a Speed Dial Number

To change or replace a stored number in speed dial simply enter the new number and store it in the memory location you wish to change.

# OPERATING INSTRUCTIONS

For example, to change the number stored in memory position 7 to 555-1111, you would press **PROG**, **7**, **555-1111**, **MEM**.

## Storing Special Codes

To insert a pause in a phone number, press and hold the number before the position where the pause is to be inserted. Hold the number key down until it beeps twice. The pause is 2 seconds in length. For longer pauses, press and hold the key until it beeps for three or four times. Each additional beep indicates an additional 2 seconds pause.

If your phone is connected to a PBX you can store the PBX access number and a pause before the phone number. For example, to store **9-PAUSE-555-1234** in memory location **8**, do the following:

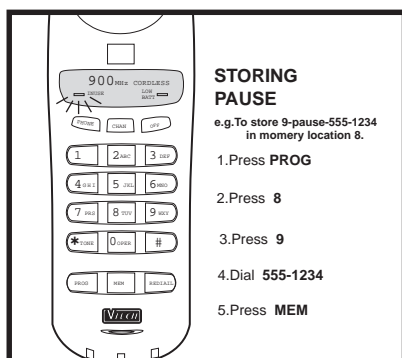

1. Press **PROG**
2. Press **8**
3. Press and hold **9** until it beeps at least twice.
4. Dial **555-1234**
5. Press **MEM**

## Using Redial

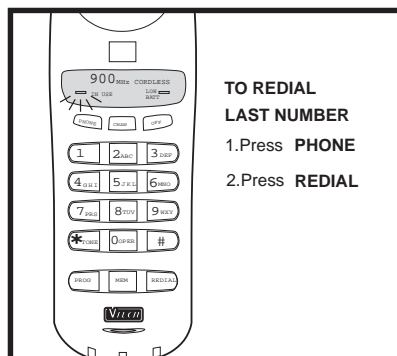

To **REDIAL** the last number you called, press **PHONE** then press **REDIAL**. The phone will automatically dial the number.

## Storing a Redial Number into Speed Dial

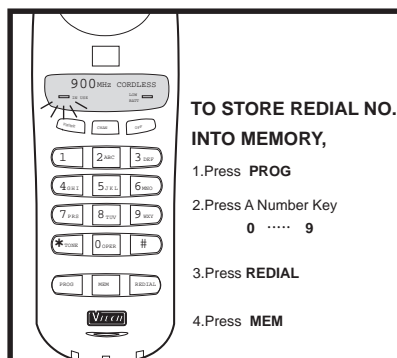

To store the last number you dialed as a regular Speed Dial number, press **PROG**, a number key (**0-9**), **REDIAL**, **MEM**.

# OPERATING INSTRUCTIONS

## The Page Feature

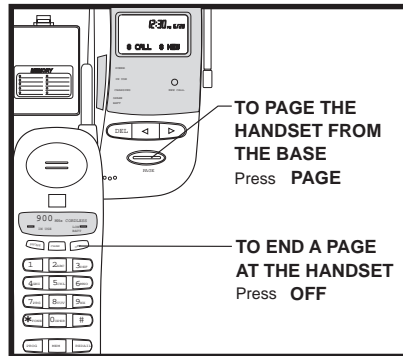

From the base unit, press **PAGE** to signal the person at the handset. To end the page at the base, press **PAGE** again. To end the page at the handset, press **OFF**.

This feature is also useful if you have misplaced the handset. To locate the handset press **PAGE** at the base. This starts a paging tone at the handset. When it is located cancel the paging tone by pressing **OFF** on the handset.

# CALLER ID

Your **VTech 912 ADLc** cordless telephone is capable of displaying the name and number of the person calling, before you answer the phone.

The unit is designed to store and display specific information provided by your local telephone company to subscribers of the "Caller Information and Identification Service" (Caller ID). When Caller ID service is active, your telephone company transmits certain information between the first and second ring of each call. This information includes the telephone number and name of the caller as well as the date and time of the call.

For example:  
NUMBER ONLY:

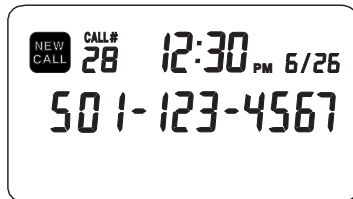

NAME AND NUMBER:

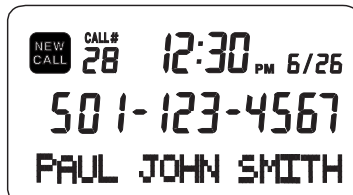

This information is immediately displayed on the unit's LCD screen, enabling you to identify the calling party without having to answer the call. Simultaneously, this information is stored in memory for review at a later time.

**You must be in an area where Caller ID service is available and you must subscribe to this service to use this feature.**

Caller ID service is based a relatively new technology. In some areas, Caller ID service is not fully supported, or not offered at all. Caller ID may not work properly in some areas due to local telephone company limitations and/or equipment incompatibility.

## Caller ID LCD and Icons

Caller ID information is displayed on the Base LCD module. Each ICON has a specific function.

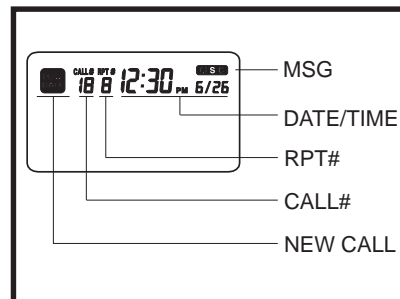

## New Call Icon (NEW CALL)

When activated, this icon alerts the users that new calls have been received. The **NEW CALL** icon will remain on until all new calls are reviewed.

## Call Counter (CALL#)

This two digit counter indicates the position of CID record relative to other records stored in CID memory.

## Repeat Counter (RPT#)

This digit counter is used to indicate when a specific call has been received more than once. If a call had been received twice, the **RPT#** counter would show a 1. The repeat counter is only active during Caller ID review when a repeat call comes in.

# CALLER ID

## DATE / TIME Stamp

The date and time fields are used to display the date and time information of a Caller ID record. Also, if no keys on the Caller ID module are touched for around 20 to 30 seconds, the display will default to Clock mode, and display the current date and time.

## Message Waiting Icon (MSG)

The **VTech 912 ADLc** is capable of detecting a visual Message Waiting signal generated by some local phone company Voicemail systems. If you subscribe to Voicemail services, and the visual Message Waiting signal is provided by your local telephone company, the **MSG** icon will be displayed when you have messages waiting. If you do not use Voicemail services, the **MSG** icon will not be utilized.

Once you have checked your Voicemail messages, the central telephone office will send de-activate visual Message Waiting signal, and the **VTech 912 ADLc** will automatically deactivate the **MSG** icon.

**You must be in an area where Voicemail service is available and you must subscribe to this service to use this feature.**

## Number Display Area

The center line of the LCD is made up of 14 complete digits. This area of the LCD is used to display the phone number information of a Caller ID message. The displayed phone number will be right hand aligned. If the phone number is not available, this part of the display will be blank.

## Dot Matrix Area

The bottom line of the LCD consists of 15 5x5 dot matrix characters. The **VTech 912 ADLc** is capable of displaying caller's name information.

Caller ID name information will be displayed left-hand aligned.

In addition to displaying the name information, the dot matrix area of the LCD also displays the following:

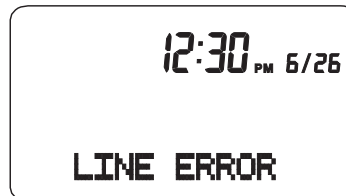

- "LINE ERROR" is displayed if errors are detected during the reception of Caller ID information. This does not indicate a problem with your unit. Notify your telephone company if it continues to appear often.

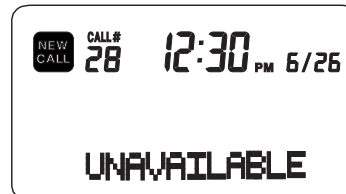

- "UNAVAILABLE " is displayed if the Caller ID name or number received is not available.

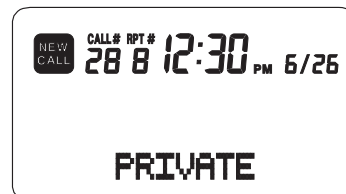

- "PRIVATE" is displayed if the calling party has identified their phone number or their name is private, or if they have temporarily blocked Caller ID transmission to protect their privacy.

# CALLER ID

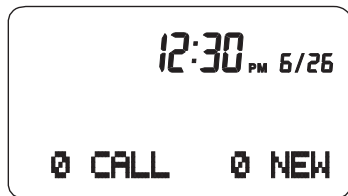

- “## CALLS ## NEW” is displayed while in clock (standby) mode. This information tells you the total number of calls received and the total number of new (not reviewed) calls.

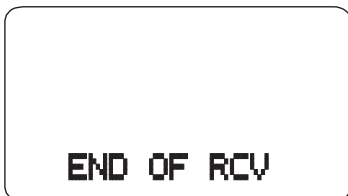

- While reviewing Caller ID numbers, if you scroll to the end of the received call list, the message “END OF RCV” is displayed.



- If no calls have been received, the message “NO CALL” is displayed during call review.
- During initial setup several messages are displayed to prompt you through language selection and Time/Date setting. See “Caller ID Setup”.

**NOTE:**  
The *VTech 912 ADLc* may also display messages which are generated by your local telephone company. An example of these messages are “LONG DISTANCE”, “CALL FORWARD” or “PAY PHONE”.

## Caller ID Operating Key Descriptions

The *VTech 912 ADLc* has three keys on the base unit for operation of the Caller ID module.

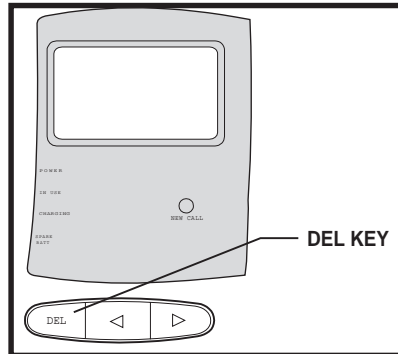

- **DEL.** This key is primarily used to delete stored numbers in the Caller ID memory. See “Deleting Caller ID Memory”, page 23. The **DEL** key is also used during initial setup to select language and Time/Date information. See “Caller ID Setup”, page 22.

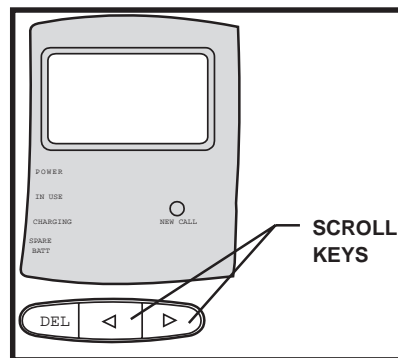

- **Scroll Keys** (◀ and ▶). These keys are used to review the Caller ID memory. See “Reviewing Caller ID Information”, page 23. Scroll keys are also used during initial setup, see “Caller ID Setup”, page 22.

# CALLER ID

## Caller ID Setup

When you first plug-in your **VTech 912 ADLc** you will be prompted to perform several setup procedures.

The setup process is automated. After confirming a selection, the unit will automatically move to the next step of the setup procedure.

The 912 ADLc is capable of displaying Caller ID information in English, Spanish, or French. The first message you will see is:



One second later the LCD will switch to:

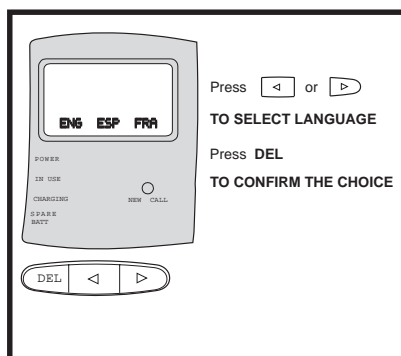

Using the scroll keys (◀ and ▶) select the language you want to display. Your current selection will begin to flash. To confirm this choice and move to the next step, press the **DEL** key.

After selecting the language (assume **ENG** was selected), the LCD will then display the digits of the Time and Date, and the following message will appear:

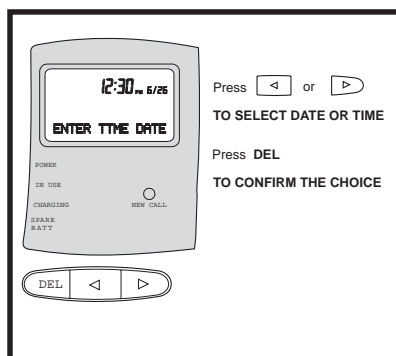

## Enter Time:

- Using the scroll keys (◀ and ▶) select the correct hour (1,2,3,...12). To confirm your selection press the **DEL** key.
- Using the scroll keys (◀ and ▶) select the correct minute (0,1,2,...59). To confirm your selection press the **DEL** key.
- Using the scroll keys (◀ and ▶) select the either AM or PM. To confirm your selection press the **DEL** key.

## Enter Month / Day:

- Using the scroll keys (◀ and ▶) select the correct number for the current month (1,2,3,...12). To confirm your selection press the **DEL** key.
- Using the scroll keys (◀ and ▶) select the correct number for the current day (1,2,3,...31). To confirm your selection press the **DEL** key.

If you make a mistake during setup you must restart the setup process. First, do not press any keys on the unit for 30 seconds. After this time, the unit will default to the clock (standby) mode. To re-enter the setup process, press and hold both scroll keys (◀ and ▶) for 6 seconds.

# CALLER ID

You can now update the time and date information. All stored CID records will be retained.

If you want to perform a complete reset, press and hold all 3 keys ( DEL, ► and ◀ ) continuously for 6 seconds. In this case, all stored CID records will be erased.

## Reviewing Caller ID Information

All received calls are sequentially numbered and stored in memory for later review. The 912 ADLc has the capacity to hold up to 99 Caller ID records for review. If you have 99 calls stored in memory and you receive another call, the oldest call record is automatically dropped from the record to make room for the new Caller ID information.

When an incoming call occurs, the base will automatically display the Caller ID information. All unanswered calls are considered new calls. The unit keeps track of all new calls. The **NEW CALL** icon is turned on, and upon returning to clock mode, the New Call LED will begin to flash and the number of new calls and total calls are displayed on the LCD.

For example, suppose you were not at home, but had received 6 calls while you were out. The **NEW CALL** icon would be activated, the New Call LED would begin to flash, and the LCD would display the following message:

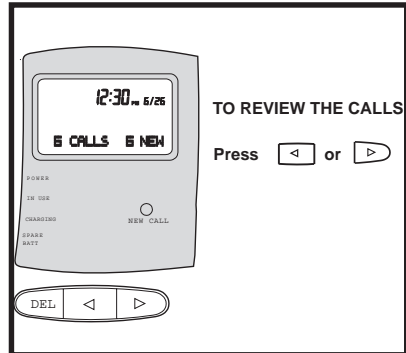

To review the calls, simply press the ◀ and ▶ keys to scroll through the Caller ID memory. The ◀ key moves backward through the list, while the ▶ key moves forward. When you reach the end of the call log, the message “**END OF RCV**” is displayed. You can also roll-over from the end of the call log to the beginning by pressing the scroll key on additional time.

## Repeat Counter

If you receive more than one call from the same number, the 912 ADLc tracks these as repeat calls, and activates the repeat counter. When you review individual Caller ID records and the **RPT#** icon is on, then the current number being displayed was repeated. The digit below the **RPT#** icon indicates the number of times this number was repeated. Also, the Time / Date information displayed for this record will be for the most recent call received from this number.

# CALLER ID

## **Deleting Caller ID Memory**

While in Caller ID review mode, the calling party's name and telephone number are displayed on the LCD. If you wish to delete an individual call from Caller ID memory, press the **DEL** key twice within 1.5 seconds. This will delete a single entry only.

If you want to delete the entire Caller ID memory, press and hold the **DEL** key for 6 seconds.

## **Manual Reset**

Should you encounter any difficulties, you can perform manual reset. Just press and hold those 3 keys ( **DEL**, **◀** and **▶** ) continuously for 6 seconds. The unit will be reset to initial setup state. Also, if there is a **POWER** failure for a long period of time, the unit will also reset to initial setup state.

In both cases, all previous **CID** information will be erased.

The following table is the language cross reference which shows all the messages given by the **CALLER ID**.

<b>ENGLISH</b>	<b>SPANISH</b>	<b>FRENCH</b>
ENTER LANGUAGE	-	-
ENG ESP FRA	-	-
ENTER TIME DATE	? TIEMPO FECHA	? HEURE DATE
NO CALL	NO LLAMADA	AUCUN APPEL
END OF RCV	FIN DE REC	FIN RECEPTION
PRIVATE	LLAMADA ANONIMA	PRIVE
UNAVAILABLE	INDISPONIBLE	INDISPONIBLE
LINE ERROR	LINEA ERRONEA	ERREUR LIGNE

# **MAINTENANCE**

## **TAKING CARE OF YOUR TELEPHONE.**

Your *VTech 912 ADLc* cordless telephone contains sophisticated electronic parts so it must be treated with care.

### **Avoid rough treatment**

Place the handset down gently. Save the original packing materials to protect your telephone if you ever need to ship it.

### **Avoid water**

Your telephone can be damaged if it gets wet. Do not use the handset outdoors in the rain, or handle it with wet hands. Do not install your base unit near a sink, bathtub or shower.

Remember that electrical appliances can cause serious injury if used when you are wet or standing in water. If your base unit should fall into water, **DO NOT RETRIEVE IT UNTIL YOU UNPLUG THE POWER CORD AND TELEPHONE LINE CORDS FROM THE WALL.** Then pull the unit out by the unplugged cords.

### **Electrical storms**

Electrical storms can sometimes cause power surges harmful to electronic equipment.

For your own safety, use caution when using electric appliances during storms.

### **Cleaning your telephone**

Your telephone has a durable plastic casing that should retain its luster for many years. Clean it only with a soft cloth slightly dampened with water or a mild soap. Do not use excess water or cleaning solvents of any kind.

# **IN CASE OF DIFFICULTY**

If you have difficulty operating your phone, the suggestions below should solve the problem. If you still have difficulty after trying these suggestions, In the US call:

**VTECH Communications at  
1-800-624-5688.**

## **THE PHONE DOESN'T WORK AT ALL.**

- Make sure the power cord is plugged in.
- Make sure the telephone line cord is plugged firmly into the base unit and the telephone wall jack.
- Make sure the batteries are properly charged. If the **Low Battery** indicator is on, the battery needs charging. If the **IN USE** indicators do not light when you press **PHONE**, you must charge the batteries.
- If you recently installed a new battery pack, make sure it is installed correctly.

## **NO DIAL TONE.**

- First check all the suggestions above.
- If you still don't hear a dial tone, disconnect the base unit from the telephone jack and connect a different phone. If there is no dial tone on that phone either, the problem is in your wiring or local service. Call your local telephone company.

## **YOU GET NOISE, STATIC, OR A WEAK SIGNAL EVEN WHEN YOU'RE NEAR THE BASE UNIT.**

- Place the handset in the base momentarily to re-set the security code. Then press **PHONE** to get a line.

Household appliances plugged into the same circuit as the base unit can sometimes cause interference. Try moving the appliance or the base unit to another outlet.

## **YOU GET NOISE, STATIC, OR A WEAK SIGNAL WHEN YOU'RE AWAY FROM THE BASE UNIT.**

- You may be out of range. Either move close to the base, or relocate the base unit.
- The layout of your home may be limiting the range. Try moving the base unit to the second or third floor, or to some other location.

## **THE HANDSET DOES NOT RING WHEN YOU RECEIVE A CALL.**

- Ensure that the ringer is turned on.
- Make sure the telephone line cord is plugged firmly into the base unit and the telephone jack. Make sure the power cord is plugged in.
- You may be too far from the base unit.
- You may have too many extension phones on your telephone line to allow all of them to ring. Try unplugging some of the other phones.

## **YOUR CALLER FADES IN AND OUT.**

You may be nearly out of range. Move closer, or relocate the base.

## **YOU HEAR OTHER CALLS WHILE USING YOUR PHONE.**

- Replace the handset in the base cradle, wait a few moments and try again.
- Disconnect your base unit from the telephone jack, and plug in a regular telephone. If you still hear other calls, the problem is probably in your wiring or local service. Call your local telephone company.

# **IN CASE OF DIFFICULTY**

## **YOU HEAR NOISE IN THE HANDSET, AND NONE OF THE KEYS OR BUTTONS WORK.**

- Make sure the power cord is plugged in.
- Your base unit and handset may not be operating on the same channel or security code. Place the handset in the cradle for a few moments to reload the security code and reset the channel.

## **COMMON CURE FOR ELECTRONIC EQUIPMENT**

Electronics, like people, can sometimes get confused. If the unit does not seem to be responding normally, then try putting the handset in the cradle to re-initialize the unit. If it still does not seem to respond, perform the following steps (in the order listed):

1. Disconnect the power to the base.
2. Disconnect the handset battery.
3. Wait a few minutes.
4. Connect power to the base.
5. Connect the handset battery.
6. Put the handset in the base to re-initialize.

# **WARRANTY STATEMENT**

---

## **WHAT DOES OUR WARRANTY COVER?**

- Any defect in material or workmanship.

## **FOR HOW LONG AFTER THE ORIGINAL PURCHASE?**

- One Year.

## **WHAT WILL VTECH DO?**

- At our option, repair or replace your unit.

## **HOW DO I SEND MY UNIT, IN OR OUT OF WARRANTY?**

- Call VTECH Communications customer service for Return Authorization at:  
**1-800-624-5688**
- Properly pack your unit. Include any cables & accessories which were originally provided with the product. We recommend using the original carton and packing materials.
- Include in the package a copy of the sales receipt or other evidence of date of original purchase (if the unit was purchased within the last twelve months).
- Print your name and address, along with a description of the defect, and include this in the package.
- Include payment for any service or repair not covered by warranty, as determined by VTECH Communications.
- In the US, ship the unit via UPS Insured, or equivalent to:

**VTECH COMMUNICATIONS**  
8770 SW NIMBUS AVENUE  
BEAVERTON, OREGON 97008

*VTECH Communications assumes no responsibility for units sent without prior Return Authorization.*

## **WHAT DOES OUR WARRANTY NOT COVER?**

- Batteries
- Damage from misuse, neglect, or acts of nature (lightning, floods, power surges, etc.)
- Products which may have been modified or incorporated into other products
- Products purchased outside the USA
- Products serviced by the owner or a service facility not expressly authorized by VTECH Communications
- Products purchased more than 12 months from current date

## **HOW DOES STATE LAW RELATE TO THIS WARRANTY?**

- This warranty gives you specific rights. You may also have other rights which vary from state to state.

# FCC REGULATIONS

This equipment complies with Parts 15 and 68 of the Federal Communications Commission (FCC) rules for the United States.

A label is located on the underside of the base unit containing either the FCC registration number and Ringer Equivalence Number (REN). You must, upon request, provide this information to your local telephone company.

This equipment is compatible with inductively coupled hearing aids.

Should you experience trouble with this telephone equipment, please contact:

**In the United States:  
VTECH COMMUNICATIONS  
1-800-624-5688**

for repair/warranty information. The telephone company may ask you to disconnect this equipment from the line network until the problem has been corrected.

Your **912 ADLc** is designed to operate at the maximum power allowed by the FCC. This means your handset and base unit can communicate only over a certain distance - which will depend on the location of the base unit and handset, weather, and the construction and layout of your home or office.

## FCC Part 15

**Warning:** Changes or modifications to this unit not expressly approved by the party responsible for compliance's could void the user's authority to operate the equipment.

The equipment has been tested and found to comply with part 15 of the FCC rules. These limits are designed to provide reasonable protection against harmful interference in a residential installation. This equipment generates, uses and can radiate radio frequency energy and, if not installed and used in accordance with the instructions, may cause harmful interference to radio communications. However, there is no guarantee that interference will not occur in a particular installation. If this equipment does cause harmful interference to radio or television reception, which can be determined by turning the equipment off and on, the user is encouraged to try and correct the interference by one or more of the following measures:

- Reorient or relocate the receiving antenna.
- Increase the separation between the equipment and receiver.
- Connect the equipment into an outlet or on a circuit different from that to which the receiver is connected.
- Consult the dealer or an experienced radio/TV technician for help.

# **FCC REGULATIONS**

## **FCC Part 68**

The FCC requires that you connect your cordless telephone to the nationwide telephone network through a modular telephone jack (USOC RJ11C or RJ11W).

Your telephone company may discontinue your service if your equipment causes harm to the telephone network. They will notify you in advance of disconnection, if possible. During notification, you will be informed of your right to file a complaint with the FCC.

Occasionally, your telephone company may make changes in its facilities, equipment, operation, or procedures that could affect the operation of your equipment. If so, you will be given advance notice of the change to give you an opportunity to maintain uninterrupted service.

The base unit contains no user serviceable parts. The handset contains a user replaceable battery pack.

If it is determined that your telephone equipment is malfunctioning, the FCC requires that it not be used and that it be unplugged from the modular jack until the problem has been corrected. Repairs to this telephone equipment can only be made by the manufacturer or its authorized agents or by others who may be authorized by the FCC. For repair procedures, follow the instructions outlined under the VTECH Limited Warranty.

This equipment may not be used on coin service provided by the phone company or Party Lines.

The REN is useful in determining the number of devices you may connect to your telephone line and still enable the devices to ring when you receive a call. The general rule is that the REN value should not exceed 5.0 total; however, contact your local telephone company for the specific number in your area.

# **TECHNICAL SPECIFICATIONS**

## **FREQUENCY CONTROL**

Crystal Controlled Dual PLL Synthesizer

## **TRANSMIT FREQUENCY**

Handset: 925.05 MHz to 927.75 MHz (All ten channels within this range)

Base: 902.3 MHz to 905.0 MHz (All ten channels within this range)

## **RECEIVE FREQUENCY**

Handset: 902.3 MHz to 905.0 MHz (All ten channels within this range)

Base: 925.05 MHz to 927.75 MHz (All ten channels within this range)

## **NOMINAL EFFECTIVE RANGE**

Maximum power allowed by FCC. Actual operating range may vary according to environmental conditions at the time of use.

The range quoted for this phone is based on open field measurements under ideal conditions.

## **SIZE**

Handset: 18.2cm x 6.2cm x 3.8cm (L x W x T) maximum (antenna excluded)

Base: 21.0cmx14.8cmx 5.5cm (L x W x T) maximum (antenna excluded)

## **WEIGHT**

Handset: 500 grams  
Base: 425 grams

## **POWER REQUIREMENTS**

Handset: Self-contained nickel-cadmium rechargeable battery supply, 3.6V nominal, 600mAh capacity.

Power Adapter: 9V DC@300mA

## **CALLER ID**

Alpha Numeric display.  
99 memory locations.  
(Maximum number of CID records depends on the amount of data stored per call. A minimum of 75 CID records can be stored)

**You must be in an area where Caller ID service is available and you must subscribe to this service to use this feature.**

**SPECIFICATIONS ARE TYPICAL AND MAY CHANGE WITHOUT NOTICE.**



VTECH COMMUNICATIONS LTD.

Distributed in the U.S.A. by VTECH Communicatios, 8770 SW Nimbus Avenue /  
Beaverted, Oregon, 97008

Distributed in Canada by VTECH Electronics Canada Ltd., 200-7671 Alderbridge Way,  
Richmond, B.C., V6X1Z9

Copyright 1996 for VTECH COMMUNICATIONS LTD.

91-4028-14-00  
ISSUE 0